

DTS-01 Table Top Stand for 32 to 65 Inch Displays

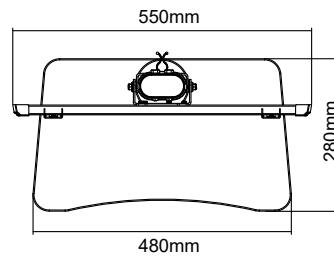

Three-level adjustable heights



Tempered glass base



Cable management

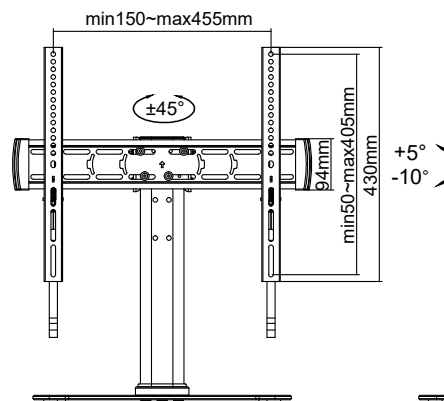

Specifications

Mounting	Display Mounting Pattern	32"-65" Displays Max. 400 x 400 mm
Loading	Weight Capacity	40.0 kg (88.0 lb)
Bracket Adjustment	Height (Three-level adjustable heights) Swivel (Right/ Left) Tilt	512.0 mm / 582.0 mm / 652.0 mm (20.2" / 22.9" / 25.7") 45° / 45° -10° to +5°
Exterior	Material Colour Glass	Metal Black Black Tempered Glass Pedestal
Dimensions	Product (W x H x D) Packaging (W x H x D) (1set)	550.0 x 652.0 x 280.0 mm (21.7" x 25.7" x 11.0") 620.0 x 360.0 x 95.0 mm (24.4" x 14.2" x 3.7")
Weight	Net Weight Gross weight (1set)	6.2 kg (13.7 lb) 6.8 kg (14.9 lb)
Packaging	1 Carton 1 Pallet	1 set 40 sets